

Servis

part of the family

9kg Tumble Dryer
S279SKRW

10kg Tumble Dryer
S2710SKRW

INSTRUCTIONS:

Please read and keep safe for future use.

Content

| | |
|--|-------|
| Warning | 2-4 |
| Part Name | 5 |
| Installation Instruction | 6-8 |
| Quick start | 9 |
| The Introduction of Function and Program | 10-12 |
| Instructions for use | 13 |
| Service guide | 14-15 |
| Troubleshooting Guide | 16-17 |
| Specification and Circuit diagram | 18 |

WARNING

● **Safety precautions**

Tips

This user's manual includes important information about installing, using and maintaining the machine. Please read the manual carefully so that you can use the clothes dryer correctly and its service life can be prolonged. Any failures and losses caused by non-compliance with the precautions specified in the installation and operation instructions are not covered by the warranty of the manufacturer, and the manufacturer will not assume any related responsibilities.

● **Warning matters**

- When the clothes dryer is working normally, please do not unplug or switch he power. When the machine is not used or cleaned, please unplug the plug, and do not pull the power cord. Do not use wet hands to plug the power cord.
- The clothes dryer cannot be installed in open air and humid environment. If the clothes dryer is accidentally drenched with water or water leaks into it, it shall be ventilated and dried before use.
- Wet clothes need to be dehydrated before being put into the clothes dryer in order to prevent water from dropping to electrical parts, which will damage the clothes dryer and cause danger.
- Please put the clothes dryer in a well-ventilated place to avoid other accidents.
- When the clothes dryer is working, don't use flammable sprays near it. When gas or flammable gas leaks, don't unplug the power plug or turn machine on or off.
- It is not allowed to dry clothes with flammable detergents, dry cleaning solvents, gasoline, banana oil and other chemicals.
- Don't disassemble, repair or refit the machine by yourself.
- When the clothes dryer is working, for safety, unattended children or disabled people are not allowed to use this machine.
- Do not use this clothes dryer when there is water on your hands and feet.
- Do not dry the raincoat, bicycle cover or other items containing rubber or similar elastic materials with the clothes dryer.

WARNING

● **Warning matters**

- Don't put anything hot or heavy (such as a pot with hot water) on the clothes dryer.
- Do not store cigarettes, lighters, dry ice, gasoline or other inflammable and explosive materials in the clothes dryer.
- The door of the clothes dryer can only be opened after the procedure is finished. Don't open the door forcibly before this so as to avoid scalding human skin due to overheating of the clothes dryer.

● **Warning signs of clothes dryer**

Please use this clothes dryer carefully if your clothes label indicates that it can't be dried by a clothes dryer!

● **Safety matters**

 In order to prevent damage to the personal and financial safety of you and others, please be sure to avoid the following matters:

- This product belongs to Class I electrical appliances. Please pay attention to the safety of electricity when using it!

1.A grounded power must be used, and the ground wire shall be directly buried in the ground, and it cannot be connected with utilities such as water pipes and gas pipelines.

2.Ensure that the cross-sectional area of wires of power system can meet the requirements of the normal electrical load.

3.Make sure to use the special socket separately for the machine.

The socket shall be the product passing China Compulsory Certification, and it must be able to carry more than 10A current. For the safety of you and your family, if the electricity in your home does not meet the above requirements, it is strictly prohibited to use the machine.

4.In order to prevent errors in the installation and use of the socket and ensure the safety of electricity utilization, it is necessary to install the socket and connect the ground wire by the personnel with electrician knowledge.

5.If it is found that the power cord is damaged, the replacement of the power cord must be carried out by professionals.



WARNING

● **Safety matters**

6. Never connect the ground wire with the firewire or the zero wire, otherwise, the shell will be electriferous, which will easily lead to the risk of electric shock.
 7. When the clothes dryer is no longer in use, it is best to unplug the power plug from the socket to ensure safety.
 8. This machine uses alternating current. When the voltage is within 10%, this machine can be used normally.
 9. If it is necessary to use a grounded leakage (grounding protection) circuit breaker, its symbol must be  which can ensure that the plug matches the and socket match.
- For safety , reasons, please use the original parts and accessories provided by the manufacturer. If the clothes dryer can no longer be used, please cut off the power cord and destroy the door hook. Waste electrical appliances should be disposed of in the designated processing center.
 - If the material of clothes is not suitable for drying by the clothes dryer, do not use this clothes dryer for drying.
 - Don't dry unwashed clothes.
 - If there is any dust hazard (such as coal and rock powder), please do not use the clothes dryer.
 - Do not lean on the door of the machine, climb or sit on the clothes dryer.
 - If the ambient temperature around the clothes dryer is lower than 0°C, it may cause frost damage.
 - Do not let children play with packaging materials.

Part name

● Attachment specification

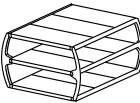
| Steelbracket <small>*This picture is only for the product with the rack and holder</small> | Externaldrain pipeassembly | Plastic bracket <small>*This picture is only for the product with the rack and holder</small> |
|---|---|--|
|  |  |  |

● Part name

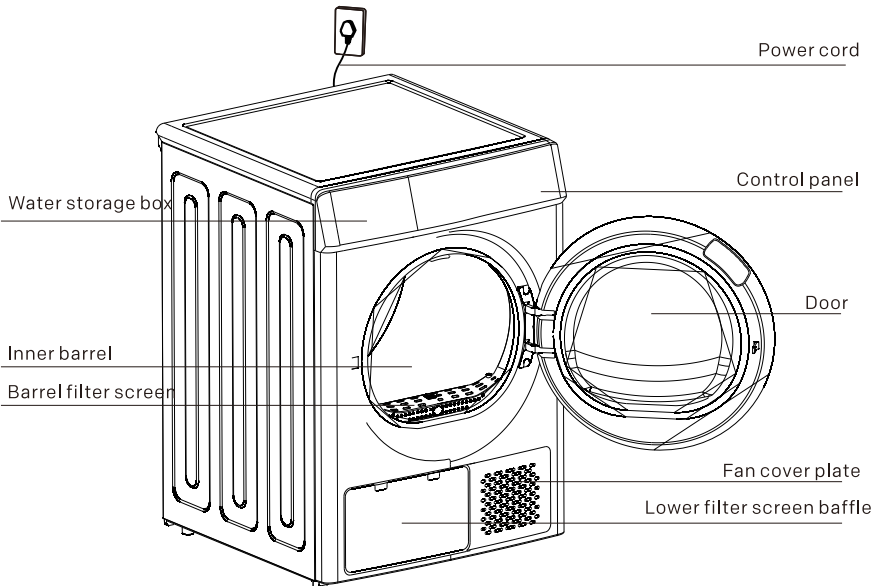

Note: This picture is a schematic diagram, which is only for reference, the machine shall be subject to the actual product.

Installation instruction

● Install the clothes dryer

1. It is recommended to place the clothes dryer and washing machine close to each other, so that clothes can be dried after washing and dehydration.
2. To avoid blocking its fan cover due to dust accumulation, the clothes dryer shall not be put in a place with much dust.
3. Please remove all packages of the clothes dryer, and then place it on a firm and flat surface, not on a blanket or a bracket.
4. When installing, adjust the feet, make the clothes dryer horizontal. Do not fill the gap between the feet and the floor with plush carpets or wooden strips, so as not to interfere with the operation of the machine.
5. Note that the installation position shall be at least 5cm away from other furniture or walls.

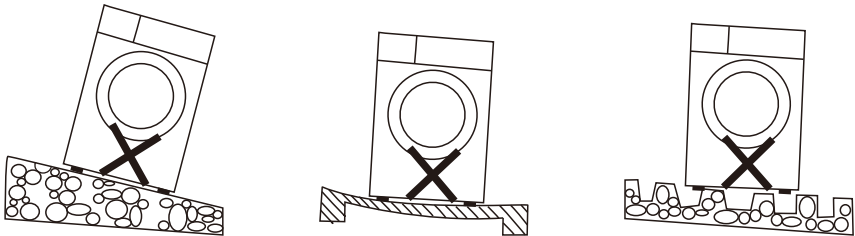

● Level adjustment

By adjusting the feet, place the clothes dryer horizontally.

1. The height can be adjusted by rotating the feet.
2. You can use tools to adjust the height of the feet of the clothes dryer.
Note: Please choose a screwdriver with a diameter less than 4.5mm as the tool for adjusting the feet.

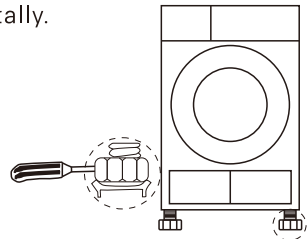

● Connection of power

1. Ensure that the power meets the requirements on the electric nameplate of clothes dryer.
2. Do not use the power strip or universal socket for secondary connection.

Installation instruction

● Accessories installation

(install them when necessary, the clothes dryer can be used normally without accessories)

(1) Installation of the external drain pipe (install it if necessary, if it is not installed, please use the water storage box)

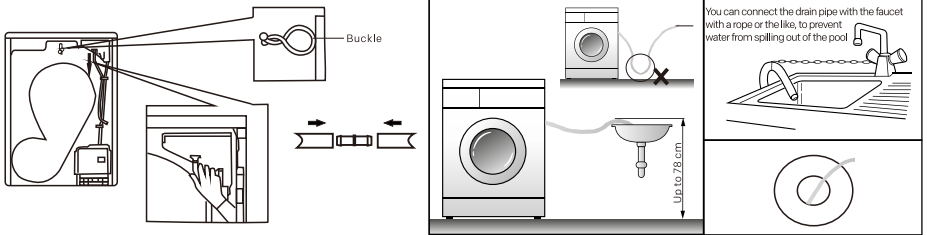

1. Pull out the upper drain pipe downward.
2. Connect the upper drain pipe with the external drain pipe.
3. Fix the external drain pipe on the buckle

Put the external drain pipe into the sink or floor drain.
(Note that don't bend the external drain pipe)

Attention: Make sure the whole pipeline is unobstructed!

Installation instruction

• Accessories installation

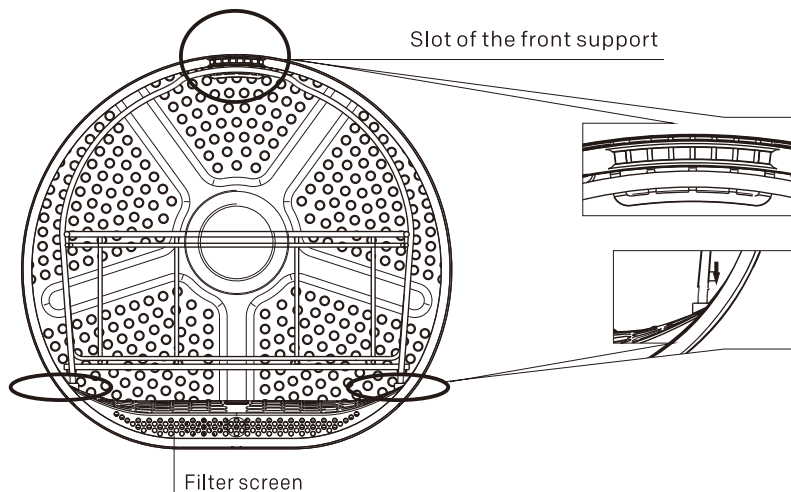

Install the steel bracket according to step 2 first, and then put the plastic bracket on the steel bracket.

*This picture is only for the product with the rack and holder

Quick start

Note: Before you use this machine, please make sure that the machine has been installed correctly according to the installation instructions.

Step 1: Preparation for drying clothes

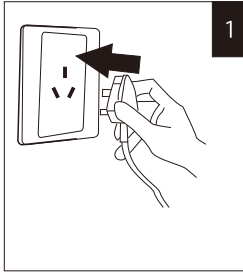

Plug in the power plug

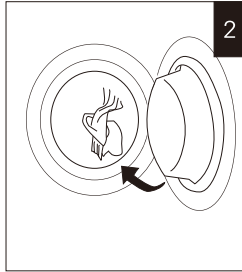

Put in clothes

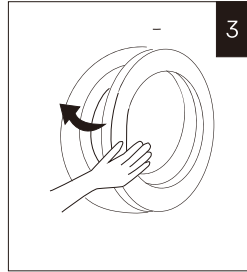

Close the door

Step 2: Start drying clothes

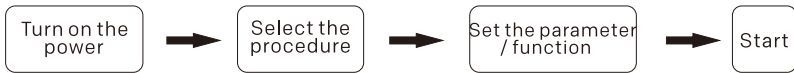

Step 3: End of drying clothes

When drying is finished, the clothes dryer will have a sound prompt or the word "End" will be displayed on the display screen.

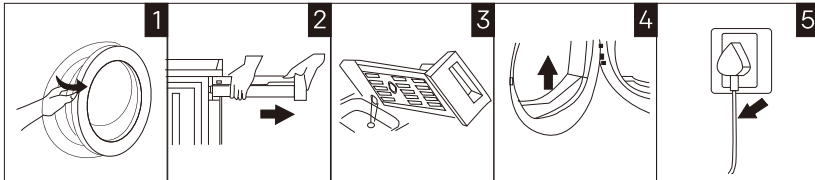

Open the door, take out the clothes

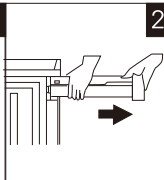

Pull the water storage box



Pour out the water in it

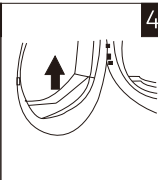

Clean the filter screen (there are two filter screens)

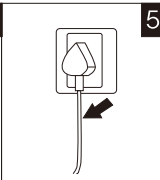

Cut off power

Note:

1. If you are using a socket with a switch, please directly press the switch to turn off power.
2. When pouring the water in the water storage box, pour it directly (without opening other parts).

The Introduction of Function and Program

● Introduction of operation panel functions

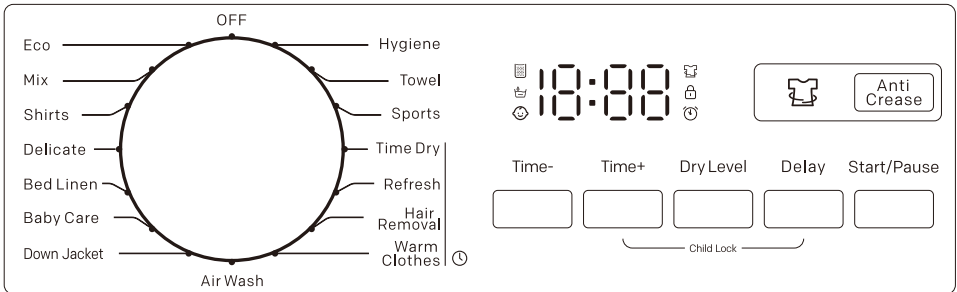

1. Start/Pause button

Press the "Start/Pause" button to start or pause the procedure.

2. Delay

Press the "Delay" button to enter the delay setting, press the "Delay" button again to select the delay time, and then press the "Start/Pause" button to start the delay. The delay time shall be selected after selecting the procedure and before pressing the "Start/Pause" button.

After the delay is started, all buttons except the "Start/Pause" button are invalid.

3. Dry Level

Press the "Dry Level" button to select the degree of dryness. Different procedures have different setting ranges for dryness. As for timing procedure, degree of dryness cannot be selected. There are 4 degrees of dryness: L0 (Iron) L1 (Normal) L2 (More) L3 (Extra)

4. Time-, time+

It is used to adjust the clothes drying time. Different procedures have different setting ranges of drying time. In some procedures, it can't choose drying time.

5. Child lock

In order to prevent children from misoperation during the machine operation, the child lock function can be turned on.

During the running of the procedure, press the "Time+" and "Delay" button to enter the child lock state, and the child lock indicator is on. Press the "Time+" and "Delay" button again to release the child lock state, and the child lock indicator goes out.

Under the child lock state, all buttons are invalid.

6. Anti Crease

In order to avoid wrinkles when clothes are piled up after drying, the clothes dryer automatically turns on the anti crease function after the drying procedure is finished. Press the "anti crease" button to turn on the anti crease function, The anti crease time is 180 minutes, and anti crease performed once every 10 minutes.

Introduction of other functions

 Filter screen indicator: Prompt the user to clean the filter screen.

 Water storage box indicator: Prompt the user to clean the water storage box.

- Add clothes halfway: During the drying, press the “Start/Pause” button, then the clothes dryer will pause, and you can open the door to add clothes.
- Reservation time refers to the time from the beginning of reservation to the end of drying.
- After the running procedure is finished, if there is no alarm, the End will be displayed, and the music will sound to prompt the user.
If the the user has no operation within 10 minutes, it will automatically switch to the wrinkle prevention procedure.
After the wrinkle prevention is completed, the machine will automatically shut down. Under the End state, if you open the door, the machine will directly enter the Shutdown state and sound a prompt.

The Introduction of Function and Program

The following procedures are applicable to 9.0/10.0 kg models:

| Name | Capacity | Introduction |
|--------------|------------|---|
| OFF | -- | Shut down the clothes dryer |
| ECO | 9.0/10.0kg | Dry cotton fabric |
| MIX | 4.5/5.0kg | For the fabric blending cotton fabric and synthetic fabric |
| Shirts | 1.0kg | Used for drying Shirts |
| Delicate | 3.0kg | Silk and other clothing that is not resistant to high temperatures |
| Bed Linen | 4.5/5.0kg | Used for heavy loads such as sheets |
| Baby Care | 1.0kg | Drying baby cotton fabric clothes |
| Down Jacket | 1.5kg | Used for drying down-filled coat/duvet |
| Air Wash | A little | Tumbles with just warm air |
| Hygiene | ≤3.0kg | For the clothes stored for a long time, carry out sterilization treatment |
| Towel | 3.0kg | Drying Towels |
| Sports | A little | Breathable clothing such as sportswear |
| Time Dry | -- | Timed Procedures |
| Refresh | A little | Timer procedure/Deodorization Freshness |
| Hair Removal | A little | Timer procedure/cleaning lint |
| Warm clothes | A little | Timing procedure/warm the clothes |

Note:

1. The above procedures are the recommended procedures, and the users can choose appropriate procedures according to their personal habits. If the clothes are not completely dried, the users can choose the timing adjustable procedure to continue drying.
2. The timing adjustable procedure will not automatically judge the degree of wetness. If the clothes are still wet after the procedure finishes, please repeat the procedure or adjust the drying time until the clothes are dried.
3. Large fabrics such as sheets or curtains are easy to be wrapped into a ball when drying. If so, stop the clothes dryer, take fabrics out and shake them, and then put them into the clothes dryer to continue drying.
4. When drying down-filled coat, before drying, please turn the inside of the clothes to the outside.
5. The time when the machine starts is the default time. In the actual operation, the temperature and humidity of the environment, the type and weight of clothes will affect the drying time. When the machine is running, the humidity sensor intelligently senses the humidity of clothes and automatically adjusts the drying time. The display time of the corresponding LED screen will increase or decrease synchronously, which is normal.
6. The procedure with icon  indicates that the procedure is a timing procedure, and it will stop when the running time ends.

Instructions for use

● Preparations before drying clothes

Note

 After handling, please stand the machine upright for more than 2 hours before using the machine, and pick soft cloth strips to clean the inner barrel before using it for the first time.

- a) Put some cloth strips in the inner cylinder.
- b) Plug in power and press the "Power" button.
- c) Select the "Timing drying" procedure and press the "Start/Pause" button.
- d) After the procedure finishes, please clean the filter screen according to the content in the "Cleaning and maintenance".

 During the operation of the clothes dryer, the compressor and drain pump will generate some sounds, and it is normal.

● Common knowledge and using skills of clothes dryer

1. Please dehydrate the clothes before putting them into the clothes dryer. The drier the clothes are after dehydration, the more time and electricity are saved when drying clothes.
2. Please shake the clothes, zip them up, button them up and put them in the clothes dryer; to avoid the zipper or button from making noise during drying, please turn the clothes outside over before putting them into the clothes dryer.
3. Clean the filter screen before starting the clothes dryer.
4. According to the prompt of the procedure name, select the corresponding drying procedure according to the material type and label information of the clothes.
5. In order to get the ideal drying effect, please classify the clothes, and don't dry the clothes with different thickness or different degrees of dryness or wetness at the same time as far as possible.
6. When drying a small amount of clothes, it is recommended to use the timing adjustable procedure.
7. When drying sheets, curtains and other large-sized fabrics, if in the drying process, the fabrics are lumped, the operation can be suspended, and drying can continue after shaking.
8. For the clothes that need to be dried by the clothes dryer, it is recommended to use fabric softener when washing.
9. Some heavy clothes (jeans, big towels, etc.) are difficult to be dried locally because of the material characteristics; if you find that the drying is still incomplete after the end of the procedure, it is recommended to use the "Timing drying" procedure to adjust the drying time.

Service guide

● Cleaning and maintenance

a、 Empty the water storage box

Steps:

- (1) Hold it with both hands and pull the water storage box;
- (2) Pour out the water in the water storage box;
- (3) Set the water storage box to its original position.

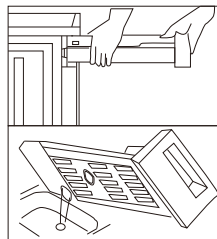

⚠ Warning

- Please clean the water storage box after each use. If the water storage box is full of water during the drying process, the procedure will pause, and the water box light on the display will be on. You shall empty the water storage box, then press the “Start/ Pause” button to restart the clothes dryer.
- Condensed water is not drinkable!
- Do not use the clothes dryer without the water storage box!

b、 Clean the filter screen assembly

The machine has one or two filter screens, it depends on the model. The filter screen shall be cleaned after each use.

Cleaning of barrel filter screen:

Open the door → take out the barrel filter screen → open the barrel filter screen → clean the barrel filter screen → put the barrel filter screen back to the original position.

Cleaning of lower filter screen:

Pull the lower filter screen baffle in the lower left corner of the machine → turn the knob → take out the lower filter screen → clean the lower filter screen → put the lower filter screen to the original position.

Cleaning steps:

- (1) Clean the filter screen and vent, remove fluff accumulated on the filter screen and vent, then rinse in running water or clean with a soft brush:
- (2) Ensure that the filter screen is completely dried before reinstalling it.

Barrel filter screen:

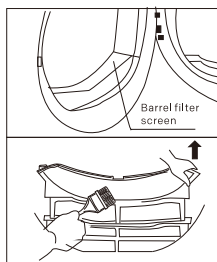

Lower filter screen:

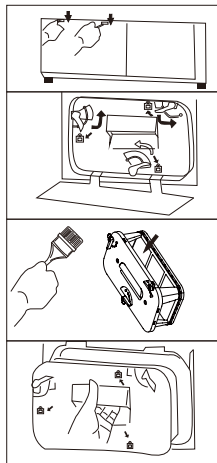

Service guide

● Cleaning and maintenance

⚠ Warning

- Too much fluff on the filter screen will block the air circulation, which will delay dryin time and increase energy consumption!
 - Do not use the clothes dryer when there is no filter screen!
 - Clean the filter screen after each use!
- c、 Clean the heat exchanger
- According to the need, it is recommended to clean the heat exchanger once every month.

Cleaning step:

- (1) Open the lower filter screen baffle in the lower left corner of the machine;
- (2) Turn the knob and take out the lower filter screen;
- (3) Clean the exchanger with a soft brush:
- (4) After cleaning, return the lower filter screen, knob and baffle to their original positions.

Note:

1. Do not press it hard when cleaning the heat exchanger, otherwise it will damage the heat exchanger.
 2. Disconnect the power before cleaning!
- d、 Clean the drum clothes dryer

⚠ Warning

- Disconnect the power before cleaning!
- Please wear gloves when cleaning.
- When cleaning the surface or other parts of the clothes dryer, use a wet cloth soaked with clean water, otherwise the plastic surface or other parts may be damaged.
- Do not rinse the clothes dryer directly with tap water hose or high-pressure water gun.

Cleaning steps:

- Prepare a wet cloth soaked in clean water.
- Clean the door, especially the internal windows.
- Clean the sealing ring around the front support.
- Clean the humidity sensor of the drum.
- Clean fluff in the air duct.

Before starting the machine, dry it with a soft cloth.

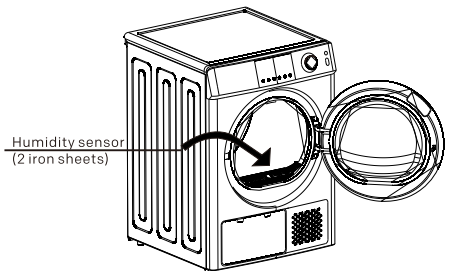
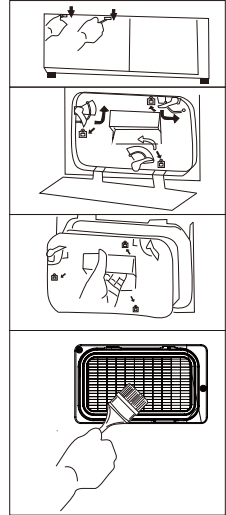

Troubleshooting Guide

● Cleaning and maintenance

Note: The humidity sensor is located inside the drum of the clothes dryer and is under the collection port.

Do not clean drum with corrosive detergent, or don't scratch the humidity sensor.

● Alarm prompt

| Alarm prompt | Alarm reason | Solution |
|--------------|---|---|
| OE | The water storage box is full or the drain pump is abnormal | If the fault is not solved after emptying the water storage box, please call the national service hotline |
| dE | The door is not closed or the door is not closed completely | If the fault has not been solved after closing the door again, please call the national service hotline |
| LE | The filter screen is not cleaned, or motor is abnormal | If the fault is not solved after cleaning the filter screen, please call the national service hotline |
| HE | The compressor is abnormal | Please turn off power and call our service number. |
| tE1 | Temperature of front air duct is abnormal | |
| tE2 | The condenser temperature is abnormal | |
| SE | The humidity sensor is abnormal | |

Remarks:

When  appears during the machine operation, please check whether the water storage box is full. If so, please empty it and restart the machine. If not, please start the machine directly.

When  appears during the running machine, please check whether the barrel filter screen and the lower filter screen are full. If the filter screen is full of fluff, please clear it and restart the machine; if not, please start the machine directly.

Troubleshooting Guide

● Fault phenomena and treatment methods

 Only authorized professional service technicians can repair the clothes dryer!

Before calling the hotline, please confirm whether you can handle the trouble by yourself or the machine is used correctly, the technicians will give you advice when it is within the warranty period.

| Problem | Solution |
|--|---|
| The computer panel does not display any content | Check whether the power or power plug is normal; check whether the power switch is turned on. |
| The clothes dryer is not started | Confirm whether the door of the clothes dryer is closed. Confirm whether the procedure is selected and the "Start/Pause" button is pressed. |
| The door opens automatically | Press and hold the door handle, so that the door lock can be locked in the corresponding position. Check whether the clothes are excessive. |
| The drying standard is not reached or the drying time is too long. | Clean the barrel filter screen and lower filter screen; use a more appropriate drying procedure; ensure that the fan cover is unobstructed. |

 If you can't eliminate the fault, please:

1. Turn off power of the clothes dryer.
2. Call our service number.

Specification

| Model | S279SKRW | S2710SKRW |
|-----------------------------------|-------------|-------------|
| Maximum drying capacity (kg) | 9.0 | 10.0 |
| Rated power (W) | 650 | 700 |
| Product size (w*d*h) (mm) | 595*615*850 | 595*670*850 |
| Net weight (kg) | 45 | 52 |
| Gross weight (kg) | 50 | 58 |
| Refrigerant | R290 | R290 |
| Filling amount of refrigerant (g) | 105 | 110 |

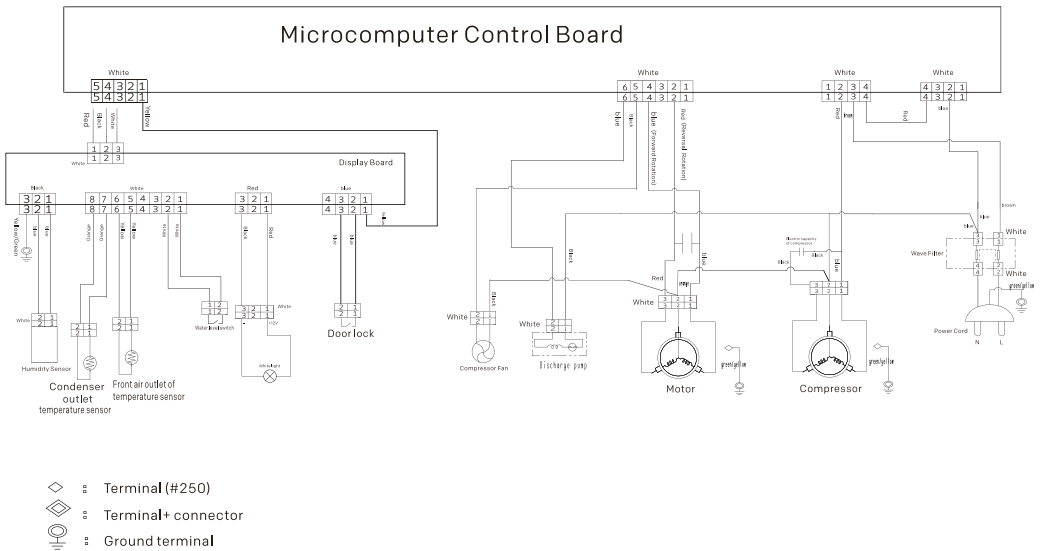

This marking indicates that this product should not be disposed with other household wastes throughout the EU.

To prevent possible harm to the environment or human health from uncontrolled waste disposal, recycle it responsibly to promote the sustainable reuse of material resources.

To return your used device, please use the collection systems or contact the retailer where the product was purchased.

They return and can take this product for environmental safe recycling.

There are separate collection systems for used electrical and electronic products. Please help us keep the environment clean.



This product is designed and corresponds to all European directives and requirements.



Product Information Sheet

COMMISSION DELEGATED REGULATION (EU) 2023/2534 with regard to energy labelling of household tumble dryers

Supplier's name or trademark: Servis

Supplier's address: Powerpoint Appliance Service, 9 Knockmitten Lane, Western Industrial Estate,, D12 WR97 Dublin 12, IE

Model identifier: S279SKRW

Technology of tumble dryer | Electric condenser

General product parameters:

| Parameter | Value | Parameter | Value | |
|--|----------------|---|--------|---------------|
| Rated capacity (kg) | 9,0 | Dimensions in cm | Height | 85 |
| | | | Width | 60 |
| | | | Depth | 62 |
| Energy Efficiency Index (EEI) | 79,9 | Energy efficiency class | E | |
| Condensation efficiency (%) (if applicable) | 82 | Condensation efficiency class (if applicable) | C | |
| Weighted energy consumption in kWh per drying cycle. Actual energy consumption will depend on how the appliance is used. | 1,47 | | | |
| Programme duration (hours:minutes) | Rated capacity | 4:10 | Type | Free-standing |
| | Half | 2:05 | | |
| Acoustic airborne noise emission (dB(A) re 1 pW) | 66 | Acoustic airborne noise emission class | C | |
| Off-mode (if applicable) (W) | 0,40 | Standby mode (if applicable) (W) | - | |
| Delay start (W) (if applicable) | 2,00 | Networked standby (W) (if applicable) | - | |
| For household tumble dryers equipped with a heat pump, the chemical name or the accepted industry designation of the refrigerant gas used, without prejudice to Regulation (EU) No 517/2014 on fluorinated greenhouse gases. | | | R290 | |
| Repairability information: | | | | |
| Repairability Class (based on the index below) | | | A | |
| Repairability Index | | | 9,48 | |
| Disassembly Depth (S _{DD}) score | | | 8,84 | |
| Fasteners type score (S _F) | | | 10,00 | |

| | |
|---|--|
| Tools type score | 10,00 |
| Repair information score (S_{RI}) | 10,00 |
| Weblink to information on spare parts availability for professional repairers and end users | www.servisappliances.ie |
| Weblink to repair instructions for end-users | www.servisappliances.ie |
| Weblink to indicative pre-tax prices | www.servisappliances.ie |
| Minimum duration of the guarantee offered by the supplier | 12 |
| Additional information: | |
| Link to the supplier's website, where the information in point 6 of Annex II to Commission Regulation (EU) 2023/2533 is found: www.servisappliances.ie | |

Model placed on the Union market from 10/06/2025.



EPREL registration number: 2384420

<https://eprel.ec.europa.eu/qr/2384420>

Supplier: Shomar Ltd (Manufacturer)

Website: www.shomar.ie & www.powerpointappliance.ie & www.thorappliances.ie & www.servisappliance.ie

Customer care service:

Name: Powerpoint Appliance Service

Website: www.powerpointappliances.ie

Email: service@shomar.ie

Phone: 014505327

Address:

9 Knockmitten Lane, Western Industrial Estate,
D12 WR97
Ireland

Product Information Sheet

COMMISSION DELEGATED REGULATION (EU) 2023/2534 with regard to energy labelling of household tumble dryers

Supplier's name or trademark: Servis

Supplier's address: Powerpoint Appliance Service, 9 Knockmitten Lane, Western Industrial Estate,, D12 WR97 Dublin 12, IE

Model identifier: S2710SKRW

Technology of tumble dryer | Electric condenser

General product parameters:

| Parameter | Value | Parameter | Value | |
|--|----------------|---|--------|---------------|
| Rated capacity (kg) | 10,0 | Dimensions in cm | Height | 85 |
| | | | Width | 60 |
| | | | Depth | 67 |
| Energy Efficiency Index (EEI) | 79,1 | Energy efficiency class | E | |
| Condensation efficiency (%) (if applicable) | 82 | Condensation efficiency class (if applicable) | C | |
| Weighted energy consumption in kWh per drying cycle. Actual energy consumption will depend on how the appliance is used. | 1,55 | | | |
| Programme duration (hours:minutes) | Rated capacity | 4:20 | Type | Free-standing |
| | Half | 2:15 | | |
| Acoustic airborne noise emission (dB(A) re 1 pW) | 66 | Acoustic airborne noise emission class | C | |
| Off-mode (if applicable) (W) | 0,40 | Standby mode (if applicable) (W) | - | |
| Delay start (W) (if applicable) | 2,00 | Networked standby (W) (if applicable) | - | |

For household tumble dryers equipped with a heat pump, the chemical name or the accepted industry designation of the refrigerant gas used, without prejudice to Regulation (EU) No 517/2014 on fluorinated greenhouse gases.

R290

Repairability information:

Repairability Class (based on the index below)

A

Repairability Index

9,48

Disassembly Depth (S_{DD}) score

8,84

Fasteners type score (S_F)

10,00

| | |
|---|--|
| Tools type score | 10,00 |
| Repair information score (S_{RI}) | 10,00 |
| Weblink to information on spare parts availability for professional repairers and end users | www.servisappliances.ie |
| Weblink to repair instructions for end-users | www.servisappliances.ie |
| Weblink to indicative pre-tax prices | www.servisappliances.ie |
| Minimum duration of the guarantee offered by the supplier | 12 |
| Additional information: | |
| Link to the supplier's website, where the information in point 6 of Annex II to Commission Regulation (EU) 2023/2533 is found: www.servisappliances.ie | |

Model placed on the Union market from 10/06/2025.



EPREL registration number: 2384740

<https://eprel.ec.europa.eu/qr/2384740>

Supplier: Shomar Ltd (Manufacturer)

Website: www.shomar.ie & www.powerpointappliance.ie & www.thorappliances.ie & www.servisappliance.ie

Customer care service:

Name: Powerpoint Appliance Service

Website: www.powerpointappliances.ie

Email: service@shomar.ie

Phone: 014505327

Address:

9 Knockmitten Lane, Western Industrial Estate,
D12 WR97
Ireland

SERVIS STANDARD MANUFACTURER WARRANTY

TERMS AND CONDITIONS

This appliance was supplied by Shomar Ltd, Dublin. Combining years of knowledge and experience with our commitment to producing high quality appliances is what make us the country's best, fully Irish owned, Domestic Appliance Distributor. We provide all after sales service from our Headquarters in Dublin.

12 Month Warranty

This Warranty is for 12 Months from Date of Purchase and covers both Parts & Labour. Any complaints that occur during normal use of these appliances will be repaired free of charge provided the appliance has been used and maintained in accordance with the Terms and Conditions.

If a repair to your appliance is necessary evidence of purchase will be required for a call to be covered by your Warranty.

Two-year Warranty

You must register your new appliance with Shomar to avail of the **FREE** two (2) Year Warranty. Registering your appliance will allow us to contact you in the unlikely event that a modification is required. In case of an insurance loss such as theft, fire or flood, your registration will serve as proof of purchase.

Terms and Conditions

The Warranty only covers the appliance for use in a normal domestic environment. Institutional use or commercial use is not covered. (To obtain a commercial Warranty on your appliance contact us on service@shomar.ie for more details)

The following is not covered by the Warranty:

- Complaints due to the use of incorrect voltage.
- Failure of the water supply
- Failure of the electricity supply
- Failure to operate the appliance in line with the guidelines set out in the instruction manual.
- Damage to the appliance or its components however caused.
- Consumable items. E.g. Fuses, bulbs, broken glass, Knobs, Plastics.
- Blockages of Filters, drainage systems, soap dispensers etc

Note:

- Repairs or modifications carried out by anyone other than Shomar authorised agents will deem the Warranty Null and Void.

- All Gas appliances must by law be fitted by a Registered Gas Installer. For further details see WWW.RGI.IE

- Built In appliance installation and reversing the door hinges must be undertaken by a competent person.

- If in any doubt about the installation of our domestic appliances please contact us on 01-4505327 for more details.

How to log a service call:

If in the event you need to log a service call for your appliance you can contact our service department on 01-4505327 or go online to www.shomar.ie.

This Warranty does not in any way diminish or affect your statutory rights in connection with the product. This Warranty is in addition to your statutory rights as a consumer. If you have any questions about these rights, please contact the retailer from which you purchased the product. In certain circumstances, it is possible that your statutory rights may offer additional or higher levels of protection than those offered under the terms of this Warranty.

This Warranty applies only to the cost of repairing the product. To the extent permitted by law, the Manufacturer does not accept and will not be held liable for any financial loss incurred in connection with the failure of any product to operate in accordance with the expected standards. Such financial loss includes but is not limited to loss arising from:

- Food Loss
- Time taken from work
- Damaged clothing or other items
- Laundry costs
- Meals from Restaurant /Takeaways
- General Compensation for Inconvenience

Does PowerPoint offer replacements?

This is a repair-only Warranty. On occasion, the Manufacturer may at its sole discretion, replace your product with a new product instead of carrying out a repair. In the unlikely event we cannot repair your appliance it will be replaced free of charge, replacement will be authorised and provided by the retailer upon contact from the manufacturer.

Any costs related to disconnecting the faulty product and installing the replacement product will not be borne by the Manufacturer unless previously agreed to in writing.

The original Warranty will continue to apply to the replacement product; the new product will not come with a new Warranty.

Will I be charged for the repairs?

It is the responsibility of the consumer to provide proof of purchase to the Engineer to ensure your product is covered by this warranty. The Manufacturer reserves the right to charge for service call if:

- You cannot provide proof of purchase that your product is covered by this Warranty.
- The engineer finds that there is no fault with your product.
- That your product has not been installed or operated in accordance with the User Manual.
- That the fault was caused by something other than faulty materials, defective components or manufacturing defects.
- For missed appointments.

Payment is due immediately upon the Engineer providing you with an invoice. The Manufacturer reserves the right to terminate the Warranty if you fail to pay the costs for the service call.

The spare part availability of this appliance is 10 years. During this time, original spare parts will be available to operate the appliance properly.

This appliance was supplied by Shomar Ltd Dublin. If you would like to contact us in relation to your product for service or spare parts we can be contacted on 01-4505327 or [service@shomar .ie](mailto:service@shomar.ie).

The model information as stored in the product database can be reached by the QR Codes below or by visiting <https://eprel.ec.europa.eu/> and entering the following registration number: 2124972



N082501-000327-001(A)